



The All-Rounder

SÜ series



Benefit from our strengths

SÜ – A series of successes.

Sielaff vending machines are always at the centre of attention and ensure good turnover. The basis for this is the individual configuration of every Sielaff unit, which is location and target-group specific. No matter whether in an office, industrial company, public vending or outdoor – even in a tiny space you will make a large profit. Solutions fitting the market, turning customer wishes into successful sales.

The modular construction allows an extremely wide range of combination options. Intelligent product delivery technology conveys even bulky and delicate articles into the customers' hands. For example, the anti-tilt mechanism for tall products allows the sale of baguettes, and the innovative SoftDrop lift system transports even yoghurt, fruit or glass containers safely and gently into the goods delivery pocket.

Snacks, bags, chocolates and biscuits are stored in the spiral system and issued following the First-in-first-out principle. All machines can be fitted with various combinations of spirals and multiflex pushers which allow a specific method of product delivery for the trouble-free sale of juice cartons or similar non-food articles. The sale of heavy products is possible thanks to reinforced shelves.

Sielaff: Reliably "Made in Germany".

Benefit from our quality promise which applies to all units made by Sielaff without exception. Absolutely reliable, particularly low-maintenance and with a long service life.

Your selling advantage: Flexibility and a wide range of products.

Our spiral vendors in the SÜ series can be flexibly configured and are able to vend just about all appropriate products and allow rapid product change.

Appropriate for food use: Cool thinking.

Of course our SÜ series loves fresh food. The versions LM and 2T, specifically configured for this, are guaranteed to be suitable for the storage and sale of fresh foods.

Strong seller: inside, outside ... everywhere.

Our automatic sales professionals in the SÜ series are optimally configured for all locations. Choose the suitable version for your selling success – from High Security to Outdoor.



Snacks, bagged-items, bars and other products are dispensed with ease



Strong seller: inside, outside ... everywhere



Spirals made from high-shiny stainless steel

Talent and Technology

General facts

- Sale of sweets, snacks, fresh food and non-food articles
- 5 or 6 shelves as standard
- Capacity: up to 10 selections per shelf, up to 6 shelves, up to 60 selections
- Suitable for a vending line
- Modular construction and therefore particularly service-friendly and recyclable

Technology

- Automatic detection of the connected motors with simultaneous allocation of the selection numbers
- Electronically controlled high performance push-in chiller
- Central mains switch
- Sales data/service data logging in accordance with the EVA-DTS standard (e.g. via telemetry, MDB connection or infra-red interface)

Technology (option)

- Proper storage of fresh products in the unit (LM or 2T version)
- Locking delivery pocket for extra protection against unauthorised access
- Light bar for the monitoring of the product delivery

Energy

- Freely programmable refrigeration and illumination
- Reduction of the power consumption during the weekend or at night by means of raised temperatures and switching off of the illumination
- Energy saving LED-lighting inside

Goods compartments

- Height-adjustable stainless steel shelves
- Individual adjustments to new products on site possible
- Deep delivery pocket with swinging mechanism for tall products (e.g. baguettes)
- Option: Re-inforced product shelf
This option is required if the total weight of the products on the shelf exceeds 15 kg. A re-inforced shelf can bear a maximum weight of 30 kg.

Spirals

- First-in-First-out principle
- Spirals made from shiny stainless steel

Multiflex pushers (optional)

- Special product delivery for the easy selling of drinks cartons (up to 1.0 l) or similar packages

Refrigeration

- Low-maintenance, hermetically closed high-performance push-in chiller
- As standard HFKW-134a coolant with a GWP of 1430
- Optional: HC refrigerant R290 with a GWP of 3
- Optimised refrigeration circuit thanks to insulation and large floor filters and air outlets



Proper storage of fresh products in the unit (optional)



Appropriate for food use: Cool thinking



The variety of spiral sizes available provides numerous vending opportunities

Variants

SÜ 1500/2020 LM

- Food-grade cooling to $\leq +4^{\circ}\text{C}$ throughout the complete unit
- Electronic temperature monitoring
- Automatic blocking of sales if the temperature is exceeded

SÜ 2020 2T

- 2-temperature zones for different product groups (separation by means of controlled air flow)
 - approx. $+15^{\circ}\text{C}$ on the upper 2-3 shelves
 - food-grade storage at $\leq +4^{\circ}\text{C}$ on the lower 2-3 shelves
- Electronic temperature monitoring
- Automatic blocking of sales in the fresh food area if the temperature is exceeded

SÜ 2020 High Security

- Anti-vandalism panel
- Coin-insert slide and change drum
- Re-inforced locking lever protection
- Option: Security frame

SÜ 2020 EO

- Anti-vandalism panel
- Rain roof and splash water protection
- Locking lever protection
- Security frame
- Laminated safety glass with light filter
- Circuit breaker
- High-performance chiller unit with heating ("Frost monitoring function", internal temperature is kept above 0°C)
- Additional rear wall (advertising possible)

SÜ 2020 SoftDrop

- Intelligent lift system
- Proper handling of delicate and high value articles
 - Fresh food such as yoghurts, milkshakes, salads, sandwiches, pastries and fruit (LM or 2T version)
 - Breakable glass packaging and difficult non-food articles (e.g. paperbacks, CDs, bücher, CDs, DVDs oder Einwegfoto-DVDs or single-use cameras)
 - Car care products and accessories (particularly suitable for petrol stations)

SÜ 2020 LO (Lift Outdoor)

- All the advantages of the SoftDrop lift system with the outdoor features of the SÜ 2020 EO



SÜ 2020 High Security

SoftDrop for SÜ 2020.

The SoftDrop from Sielaff is perfect for handling fragile and high value items. Its operation is – typically Sielaff – smart, innovative and simply ingenious.

The lift travels right up to the selected product and transports even thin products effortlessly and gently to the impact-protected delivery drum.

Fresh food products such as cooked meals, yoghurts, milkshakes, salads, sandwiches, also pastry and fruit reach the customer unharmed.

Even breakable glass packaging, more awkward non-food articles such as novels, CDs, DVDs are safely delivered.

Vending from spirals : Maximum dimensions for product shape*

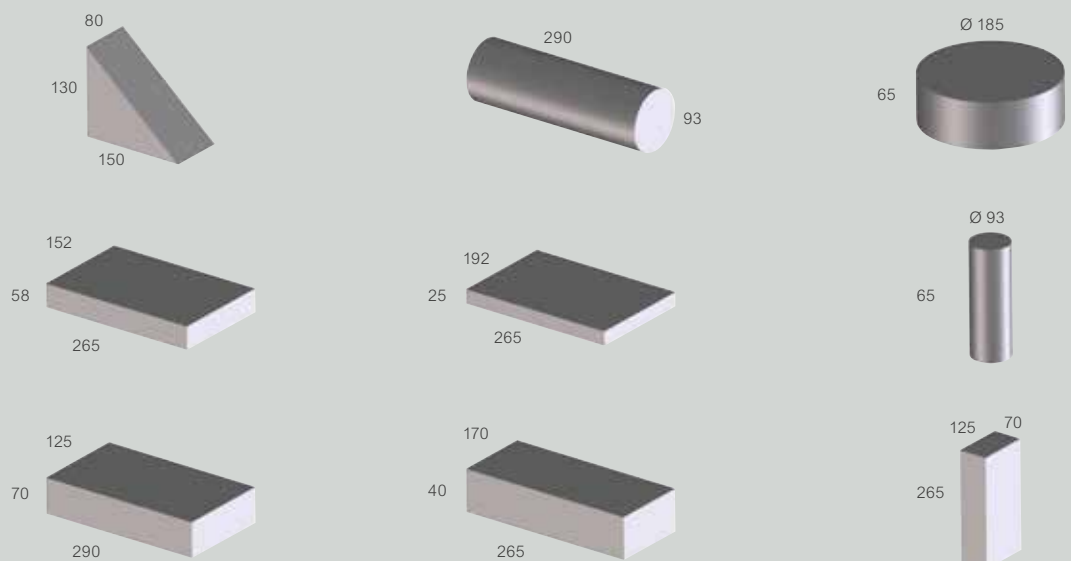

* If a given product doesn't fit in any of these shapes, it is likely that it will not vend properly.

Variants

Overview of the available variants

	SÜ	LM	2T	SoftDrop	SoftDrop LM	SoftDrop 2T
SÜ 1500 EC	X	X	–	–	–	–
SÜ 1500 HiSec	X	X	–	–	–	–
SÜ 2020 EC	X	X	X	X	X	X
SÜ 2020 HiSec	X	X	X	X	X	X
SÜ 2020 Outdoor	X	X	–	X	X	–



SÜ 1500 RB



SÜ 2020 RB



SÜ 2020 SoftDrop



SÜ 2020 High Security



SÜ 2020 RO



SÜ 2020 LO

Layouts examples

SÜ 2020

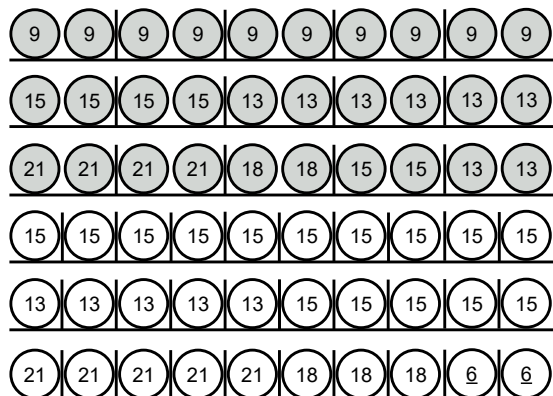

15 double selections, 30 single selections

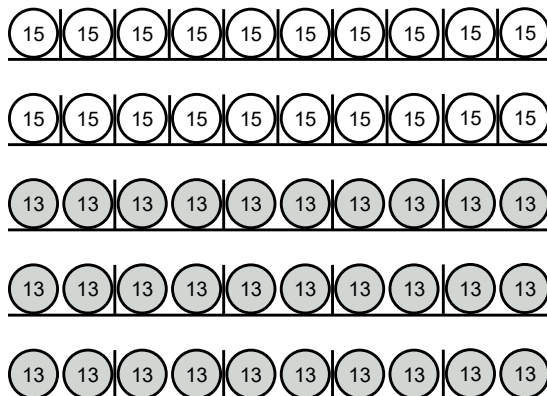

20 single selections, 15 double selections

SÜ 1500

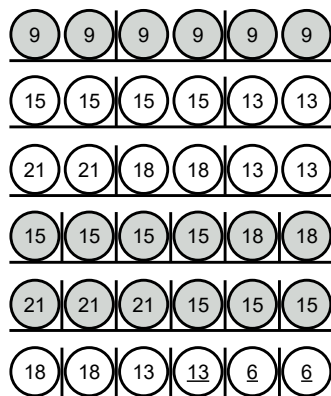

9 double selections, 18 single selections

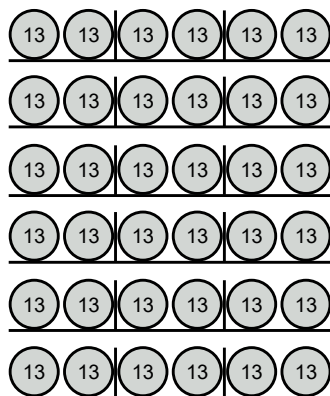

18 double selections

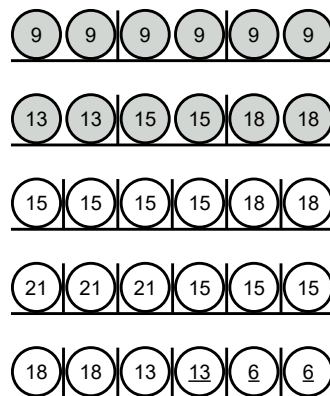

6 double selections, 18 single selections

The layouts shown are examples only. If the specification you require is not shown, then please talk to us. We will be only too pleased to advise you on location-specific solutions.



SÜ-series: flexible layout adjustments for numerous kinds of products.

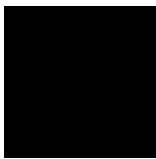

Cabinet available in
pure white (RAL 9010),
white aluminium (RAL 9006)
and jet black (RAL 9005)

* Machine dimensions may
vary due to add-on parts
and accessories



SÜ 1500 EC/RB Dimensions

- 1,830 x 700 x 880 mm
(height x width x depth)*

Weight

- Approx. 304 kg
(without products, depending
on the layout)

Electrical data

- 220–230 V/50/60 Hz/min. 10 A

Power consumption

- 400 W
(varies depending on the refrigeration)

Energy consumption labelling

- in accordance with regulation
(EU) 2019/2018 DIN 50597:2018
Refrigerants HFKW-134a
Energy efficiency category D



- HC refrigerant R-290
Energy efficiency category C



Energy efficiency for all
machine types can be
found under
[www.sielaff.de/en/
products/energy-
consumption-labeling](http://www.sielaff.de/en/products/energy-consumption-labeling)



Cabinet available in
pure white (RAL 9010),
white aluminium (RAL 9006)
and jet black (RAL 9005)

* Machine dimensions may
vary due to add-on parts
and accessories



SÜ 2020 EC/RB Dimensions

- 1,830 x 990 x 880 mm
(height x width x depth)*

Weight

- Approx. 350 kg
(without products, depending
on the layout)

Electrical data

- 220–230 V / 50/60 Hz / min. 10 A

Power consumption

- 670 W
(varies depending on the refrigeration)

Energy consumption labelling

- in accordance with regulation
(EU) 2019/2018 DIN 50597:2018
Refrigerants HFKW-134a
Energy efficiency category D – G



- HC refrigerant R-290
Energy efficiency category D



Energy efficiency for all
machine types can be
found under
[www.sielaff.de/en/
products/energy-
consumption-labeling](http://www.sielaff.de/en/products/energy-consumption-labeling)



Cabinet available in pure white (RAL 9010), white aluminium (RAL 9006) and jet black (RAL 9005)

* Machine dimensions may vary due to add-on parts and accessories



At home outside

In addition this perfectly equipped version which includes High Security features fulfils IP24 rating for outdoors and is weather-resistant to -20 °C.

Energy efficiency for all machine types can be found under www.sielaff.de/en/products/energy-consumption-labeling

Overview of the features

- Anti-vandalism panel
- Rain roof and splash water protection
- Coin-insert slide and change drum
- Re-inforced locking lever protection
- High security frame with side lock
- Laminated safety glass with light filter
- Circuit breaker
- High-performance chiller unit, heating ("Frost monitoring function", internal temperature is kept above 0° C)
- Back wall (advertising possible)

Option

- Light barrier: For monitoring product delivery following selection

SÜ 2020 EO/RO

Dimensions

- 1,855 x 1,022 x 1,000 mm (height x width x depth)*

Weight

- Approx. 400 kg (without products, depending on the layout)

Electrical data

- 220–230 V/50/60 Hz/min. 10 A

Power consumption

- 670 W (varies depending on the refrigeration)

Energy consumption labelling

- in accordance with regulation (EU) 2019/2018
DIN 50597:2018

Refrigerants HFKW-134a

Energy efficiency category D – G



HC refrigerant R-290

Energy efficiency category D



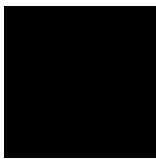

Cabinet available in pure white (RAL 9010), white aluminium (RAL 9006) and jet black (RAL 9005)

* Machine dimensions may vary due to add-on parts and accessories



At home outside

In addition this perfectly equipped version which includes High Security features fulfils IP24 rating for outdoors and is weather-resistant to -20 °C.

Energy efficiency for all machine types can be found under www.sielaff.de/en/products/energy-consumption-labeling

Overview of the features

- Anti-vandalism panel
- Rain roof and splash water protection
- Coin-insert slide and change drum
- Re-inforced locking lever protection
- High security frame with side lock
- Laminated safety glass with light filter
- Circuit breaker
- High-performance chiller unit, heating ("Frost monitoring function", internal temperature is kept above 0° C)
- Back wall (advertising possible)
- Light barrier: For monitoring product delivery following selection

SÜ 2020 LO

Dimensions

- 1,855 x 1,022 x 1,000 mm (height x width x depth)*

Weight

- Approx. 400 kg (without products, depending on the layout)

Electrical data

- 220–230 V/50/60 Hz/min. 10 A

Power consumption

- 670 W (varies depending on the refrigeration)

Energy consumption labelling

- in accordance with regulation (EU) 2019/2018
DIN 50597:2018

Refrigerants HFKW-134a

Energy efficiency category D – G



HC refrigerant R-290

Energy efficiency category D





Sielaff GmbH & Co. KG
Automatenbau Herrieden
Münchener Str. 20
91567 Herrieden
Germany

Telephone: +49 9825 18-0
Telefax: +49 9825 18-311155
export@sielaff.de
www.sielaff.com

■ MADE
■ IN
■ GERMANY

Technical data are subject to change without notice. Errors excepted.
All images shown are examples and may include optional extras.

03.2021 / 998.20.029.11 / EXP